

TEST REPORT FOR:

Virginia Department of Transportation
ET-Plus 50' (15.24 m) System 4" Channel



PREPARED FOR:

Virginia Department of Transportation
1401 E. Broad St.
Richmond, VA 23219

TEST REPORT NUMBER:

TR-P35107-05-NC

REPORT DATE:

November 10, 2015

TEST DATE:

October 2, 2015

KARCO Engineering, LLC.
Automotive and Safety Testing Facility
9270 Holly Road, Adelanto, CA 92301
Tel: (760) 246-1672 Fax: (760) 246-8112
www.KARCO.com

KARCO Engineering compiled this publication for information gathering only. The findings and conclusions expressed in this publication are those of the authors and not necessarily those of any other organization. KARCO Engineering provides test services only and is not involved in consulting, product design or the manufacturing of any automotive products. KARCO does not warrant, supervise or monitor compliance of products or services except as specifically agreed to in writing. By their very nature, testing, analysis and other KARCO services are limited in scope and subject to expected measurement variability. No activity by KARCO Engineering can release a manufacturer from product or any other liability. The results, findings and conclusions expressed in this publication relate only to the items tested for the specific situation simulated in the test.

Tested By: 
Mr. Steven D. Matsusaka
Engineering Department Supervisor

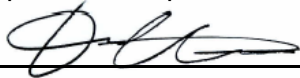
Report By: 
Mr. Steven D. Matsusaka
Engineering Department Supervisor

Approved By: 
Mr. Michael L. Dunlap
Director of Operations

Approval Date: November 10, 2015

REVISION CONTROL LOG

TR-P35107-05

Revision	Date	Description
-NC	11/10/15	Original Test Report

TABLE OF CONTENTS

<u>Section</u>		<u>Page</u>
1	Introduction	1
2	Test Procedure and Instrumentation Summary	4
3	Test Results	7
4	Data Sheets	8
<u>Data Sheet</u>		<u>Page</u>
1	Test Vehicle Information	9
2	Test Vehicle Geometry	10
3	Occupant Compartment Deformation Index	11
4	Summary of Results	12
5	Impact Conditions	13
6	Test Data Summary	14
<u>Appendix</u>		<u>Page</u>
A	Photographs	A
B	Data Plots	B
C	Instrumentation	C
D	Drawings and Illustrations	D
	Total Number of Pages	63
	Final Page of Report	D-2

SECTION 1

INTRODUCTION

1.1 OBJECTIVES

The objective of this crash test was to evaluate the impact performance of the Trinity Highway Products ET-Plus 50' (15.24 m) System 4" Channel. This report presents the results of one (1) full-scale crash test conducted on one ET-Plus 50' (15.24 m) System. For this test, the terminal section was installed on the front end of a 34.3 m (112.4 ft.) length of guardrail.

The test was conducted in accordance with instructions provided by the Virginia Department of Transportation.

1.2 TEST FACILITY

This test was conducted at KARCO Engineering's test facility in Adelanto, California. The tow road is a continuous level surface constructed of reinforced concrete and measures 850 ft. long by 14 ft. wide by 6 in. thick. A steel rail is embedded in the road to provide vehicle guidance. Vehicle tow propulsion is provided by a 1 ton truck using a 1-to-2 pulley system. The test vehicle is towed to within 25 ft. of the barrier by a nylon rope clamped to a 3/8 in. steel cable. The clamp is released from the cable on contact with a cable release mechanism positioned to allow the test vehicle to proceed under its own momentum for a maximum of 25 ft. before impacting the barrier.

1.3 TEST ARTICLE

The ET-Plus 50' (15.24 m) System 4" Channel is a guardrail terminal / end treatment. The as-tested ET-Plus 50' (15.24 m) System consisted of one (1) ET-Plus 4" Channel Guardrail Extruder Head, one (1) Hinged Breakaway (HBA) post, seven (7) Steel Yielding Terminal Posts (SYTP), one (1) standard I-beam line post, two (2) rail panels, and one (1) cable anchor assembly. The terminal section was installed with a 50:1 flare and a rail height ranging from 705 mm (27.75 in.) to 730 mm (28.75 in.) per Virginia Department of Transportation (VDOT) Road and Bridge Standards.

The first post of the terminal section was a Hinged Breakaway (HBA) post. The HBA post consists of two (2) parts: one (1) 1.8 m (5.8 ft.) long HBA bottom post and one (1) 0.7 m (2.4 ft.) long (1) HBA top post. The HBA posts are constructed of W6 x 8.5 I-beam and have a set of two (2) 13 mm (0.5 in.) thick tabs welded to one end. The posts are connected to each other at the tabs by two (2) 0.375" diameter x 2" long hex head bolt, washer, lock washer, and nut; and two (2) 0.75" diameter x 2.5" long hex head bolt, washer, lock washer, and nut. The HBA bottom post is embedded in the soil foundation and the HBA top post stands above grade.

Posts 2 – 8 were Steel Yielding Terminal Posts (SYTP) and post 9 was a standard line post. All SYTP posts and the standard line post measure 1.8 m (6.0 ft.) long and are constructed of W6 x 8.5 I-beam. A 3" x 3" angle iron strut was bolted to and connected the bases of posts 1 and 2. The strut was attached to post 1 by the 0.75" diameter x 2.5" long hex head bolt, washer, lock washer, and nut which linked the HBA top post to the HBA bottom post. The strut was attached to post 2 by two (2) 0.4375" diameter x 1.5" long hex bolts, flat washers, lock washers, and nuts.

Two (2) 7.6 m (25.0 ft.) long rail panels are mounted to the posts of the terminal section with the splice located at post 5. The rail panels are constructed of 12 Ga W-beam guardrails. The first rail panel is mounted to the first SYTP post via a 0.625" diameter x 1.25" long H.G.R bolt, washer, and nut. 191 mm (7.5 in.) plastic offset blocks are placed between the remainder of the terminal's SYTP posts and the rail panels. One (1) 0.625" diameter x 10" H.G.R. long bolt, washer, and nut is used to mount the rail to each of the SYTP posts with offset blocks. The rail is not mounted to the HBA post. The posts were spaced at a nominal distance of 1.9 m (6.25 ft.) The as-tested length of the ET-Plus 50' (15.24 m) System from post 1 to post 9 was 15.2 m (49.9 ft.).

The ET-Plus 4" Channel Guardrail Extruder Head is installed over the front rail panel and is mounted to the HBA top post by two (2) 0.375" diameter x 1.5" hex head bolts, washers, fender washers, and nuts. The cable anchor assembly anchors the rail panel to the base of the HBA post with a 19 mm (0.75 in.) thick steel cable. The upper end of the cable attaches to the rail via the cable anchor bracket which hooks onto the rail panel. The lower end of the cable is attached to the 16 mm (0.625 in.) thick bearing plate which is hooked onto the HBA post. Each end of the cable is secured by a 1" hex nut and washer which is tightened until the cable is taut.

For this test, the ET-Plus 50' (15.24 m) System was adjoined to the end of a 34.3 m (112.4 ft.) length of guardrail, measured from post 9 to post 27. The adjoining guardrail included a 3.8 m (12.4 ft.) long trailing end terminal treatment, measured from post 25 to post 27. The terminal's adjoining barrier consisted of seventeen (17) 1.8 m (6.0 ft.) long W6 x 8.5 standard I-beam line posts, one (1) 8" x 6" wood post with a soil plate and steel foundation tube, four (4) 7.6 m (25.0 ft.) long 12 Ga W-beam rail panels, one (1) 3.8 m (12.5 ft.) long 12 Ga W-beam rail panel, and one (1) cable anchor assembly. 191 mm (7.5 in.) plastic offset blocks were on all posts except the last wooden post. All of the posts, rails, and plastic offset blocks were fastened in the same manner as the SYTP posts of the ET-Plus Terminal.

With the exception of the trailing end terminal wooden post, the posts were installed by drilling 0.3 m (1.0 ft.) diameter by 0.3 m (1.0 ft.) deep pilot holes and driving the posts into the soil. The trailing end terminal wooden post was installed by drilling a 0.6 m (2.0 ft.) diameter hole and backfilling and compacting the surrounding soil with a pneumatic tamper.

Photographs of the as-tested unit and installation are available in Appendix A of this report. The installation instructions are included on KARCO CD-R 2015-3626.

SECTION 2

TEST PROCEDURE AND INSTRUMENTATION SUMMARY

2.1 TEST PROCEDURE

To meet the recommended properties of the NCHRP 350 test vehicle requirements, a commercially available production model test vehicle was selected. The test vehicle was free of major body damage and was not missing any structural components. The bumpers were standard equipment and were not modified for this test. All fluids were drained and the battery was removed.

The NCHRP 350 recommended test vehicle properties are shown in Table 1. The 820C test vehicle was used for this test. The 820C test vehicle used for this test was a front engine model with front wheel drive and an automatic transmission.

Table 1. Recommended Properties of 700C, 820C and 2000P Test Vehicles

PROPERTY	700C (Small Car)	820C (Small Car)	2000P (Pickup Truck)
MASS (kg)			
Test Inertial Dummy	700 ± 25	820 ± 25	2000 ± 45
Maximum Ballast Gross Static	75 70 775 ± 25	75 80 895 ± 25	--- 200 2000 ± 45
DIMENSIONS (cm)			
Wheelbase	230 ± 10	230 ± 10	335 ± 25
Front Overhang	75 ± 10	75 ± 10	80 ± 10
Overall Length	370 ± 20	370 ± 20	535 ± 25
Track Width (average)	135 ± 10	135 ± 10	165 ± 15
CENTER OF MASS LOCATION (cm)			
Aft of Front Axle Above Ground	80 ± 15 55 ± 5	80 ± 15 55 ± 5	140 ± 15 70 ± 5
LOCATION OF ENGINE	Front	Front	Front
LOCATION OF DRIVE AXLE	Front	Front	Rear
TYPE OF TRANSMISSION	Manual or Automatic	Manual or Automatic	Manual or Automatic

2.2 CRASH TEST SET UP

A full-scale crash test was conducted to evaluate the impact performance of the ET-Plus 50' (15.24 m) System. The test conditions were as follows: A 820 kg (1808 lb.) small car approaching the test article at a nominal speed of 100 km/h (62 mph) with a critical impact angle of 5°. The test article was installed so that the vehicle centerline intersected the leading edge of the W-beam rail.

2.3 TEST INSTRUMENTATION AND DATA ACQUISITION PROCEDURES

All data acquisition for this certification test was performed in accordance with the NCHRP 350 Recommended Procedure requirements.

2.3.1 Test Vehicle Instrumentation: The test vehicle was instrumented with one (1) tri-axial accelerometer and one tri-axial angular rate sensor. Both the accelerometer and the angular rate sensor were installed within a 5 cm radial of the vehicle's longitudinal and lateral center of gravity. The accelerometers measured longitudinal (x), lateral (y) and vertical (z) acceleration. The angular rate sensors measured vehicle roll, pitch and yaw. Data was recorded using the on-board TDAS. Data was linked to a personal computer and processed using the TDAS Control software. All equipment used in this test meets the requirements of SAE J211.

2.3.1.2 Calibration: All instrumentation used in this test has been calibrated through standards traceable to NIST and is maintained in a calibrated condition.

2.3.2 TDAS Software: The software utilized in this system is written in National Instruments Lab Windows/CVI (C, Visual Interface) programming language, which is a Windows based software package with emphasis on ease of use and good engineering test practices.

2.3.3 SAE Compatibility: The software contains standard point and click processing options for selecting Society of Automotive Engineers (SAE) class post filters and calculating the required integrals, resultants, Head Injury Criteria (HIC), clips, and other data processing parameters that may be required.

2.3.4 Measurement Uncertainty: Measurement uncertainties have been determined for pertinent values affecting the results of this test. KARCO maintains these uncertainty budgets, which are available upon request, but are not included in this report. In certain cases the nature of the test method may preclude rigorous and statistically valid calculation of uncertainty of measurement. In these cases KARCO attempts to identify the components of uncertainty and make a reasonable estimation. Reasonable estimation is based on knowledge of the performance of the method and on the measurement scope and makes use of, for example, previous experience and validation data.

2.3.5 Photographic Documentation: Photographic documentation of this test included a minimum of two (2) real-time video camera at 30 frames per second (fps), and four (4) high-speed color digital video cameras at 1000 fps All high-speed cameras were activated by a pressure-sensitive tape switch, which was positioned on the test article to indicate the instant of contact (time zero). A digital still camera was used for documenting the pre- and post-test condition of the test vehicle and the ET-Plus 50' (15.24 m) System.

2.3.6 Anthropomorphic Test Device: An uninstrumented Hybrid III 50th percentile adult male Anthropomorphic Test Device was placed in the driver seat of the test vehicle.

SECTION 3 TEST RESULTS

This 100 km/h (62 mph) impact crash test was conducted using a 2000 Chevrolet Metro small car to evaluate the impact performance of the ET-Plus 50' (15.24 m) System 4" Channel. The test article was installed at an angle of 5° relative to the test vehicle's direction of travel, with the vehicle's centerline intersecting the leading edge of the W-beam rail. This crash test was documented by two (2) real-time and four (4) high-speed video cameras. Pre- and post-test photographs of the test vehicle and test article can be found in Appendix A.

The test was conducted on October 2, 2015. The as-tested test inertial weight of the vehicle was 837.5 kg (1846.3 lbs.). The height of the front bumper was 210 mm (8.3 in.) to the lower edge and 540 mm (21.3 in.). Additional dimensions and test vehicle information are presented in Data Sheets No. 1 and 2.

The test vehicle impacted the ET-Plus 50' (15.24 m) System at a velocity of 99.22 km/h (61.65 mph). The test vehicle impacted the ET-Plus extruder head and pushed it down the guardrail past the first three posts. Shortly after the extruder head passed the third post, the rail kinked and the vehicle proceeded toward the non-traffic side of the guardrail. As the vehicle passed the third post, the kink impacted the vehicle on its left door and the vehicle began to spin counter clockwise before coming to rest. The test vehicle came to rest approximately 8.5 m (28.0 ft.) forward and 2.4 m (8.0 ft.) right of its position at the point of impact. As a result of the impact, the HBA top post broke away from the HBA bottom post and the first two SYTP posts yielded at grade level. The third SYTP post moved within its foundation. The rail separated from posts 1 through 4 and partially tore within the extruder head. An overhead illustration of the test vehicle and test article in their pre-test and post-test conditions is shown in Figure 62 in Appendix D. Sequential photographs of the test sequence are shown on Data Sheet 4.

The vehicle sustained damage to the front end including the bumper, grill, hood, and to the left front fender, and left door as a result of the impact with the ET Plus 50' (15.24 m) System. The occupant compartment was not penetrated as a result of the impact.

A summary of the electronic data is presented in Data Sheet No. 6; data plots are presented in Appendix B.

SECTION 4
DATA SHEETS

Test Article: ET-Plus 50' (15.24 m) System 4" Channel Project No. P35107-05
 Test Program: 100 km/h 5° Guardrail Terminal Impact Test Test Date: 10/02/15

CONVERSION FACTORS

Quantity	Typical Application	Std Units	Metric Unit	Multiply By
Mass	Vehicle Weight	lb	kg	0.4536
Linear Velocity	Impact Velocity	miles/hr	km/hr	1.609344
Length or Distance	Measurements	in	mm	25.4
Volume	Fuel Systems	gal	liter	3.785
Volume	Small Fluids	oz	mL	29.574
Pressure	Tire Pressures	lbf/in ²	kPa	6.895
Temperature	General Use	°F	°C	$=(T_f - 32)/1.8$
Force	Dynamic Forces	lbf	N	4.448
Moment	Torque	lbf-ft	N•m	1.355

DATA SHEET 1

TEST VEHICLE INFORMATION

Test Article: ET-Plus 50' (15.24 m) System 4" Channel Project No. P35107-05
 Test Program: 100 km/h 5° Guardrail Terminal Impact Test Test Date: 10/02/15

TEST VEHICLE INFORMATION

Make	Chevrolet	Cylinders	Inline 4
Model	Metro	Engine Displacement (L)	1.0
Body Style	3-Door Hatchback	Engine Placement	Transverse
VIN	2C1MR2226Y6713745	Fuel Type	Gasoline
Color	Black	Transmission	Automatic
Odometer Reading (mi)	161,635	Final Drive	Front
Previous Damage to Vehicle	Minor dents and scratches		

DATA FROM CERTIFICATION LABEL

Manufactured By	Cami Automotive Inc. Canada	GVWR (kg)	1190
		GAWR Front (kg)	650
Date of Manufacture	Dec-99	GAWR Rear (kg)	560

TEST VEHICLE WEIGHTS

	As Received (kg)			Test Inertial (kg)			Gross Static (kg)		
	Front	Rear	Total	Front	Rear	Total	Front	Rear	Total
Left	279.0	156.5	435.5	266.0	146.5	412.5	295.0	174.5	469.5
Right	274.0	163.0	437.0	270.0	155.0	425.0	279.0	164.5	443.5
Ratio (%)	63.4	36.6	100.0	64.0	36.0	100.0	62.9	37.1	100.0
Total	553.0	319.5	872.5	536.0	301.5	837.5	574.0	339.0	913.0

	As Received (lb)			Test Inertial (lb)			Gross Static (lb)		
	Front	Rear	Total	Front	Rear	Total	Front	Rear	Total
Left	615.1	345.0	960.1	586.4	323.0	909.4	650.4	384.7	1035.1
Right	604.1	359.3	963.4	595.2	341.7	936.9	615.1	362.7	977.8
Ratio (%)	63.4	36.6	100.0	64.0	36.0	100.0	62.9	37.1	100.0
Total	1219.2	704.3	1923.5	1181.6	664.7	1846.3	1265.5	747.4	2012.9

DATA SHEET 2

TEST VEHICLE GEOMETRY

Test Article: ET-Plus 50' (15.24 m) System 4" Channel Project No. P35107-05
 Test Program: 100 km/h 5° Guardrail Terminal Impact Test Test Date: 10/02/15

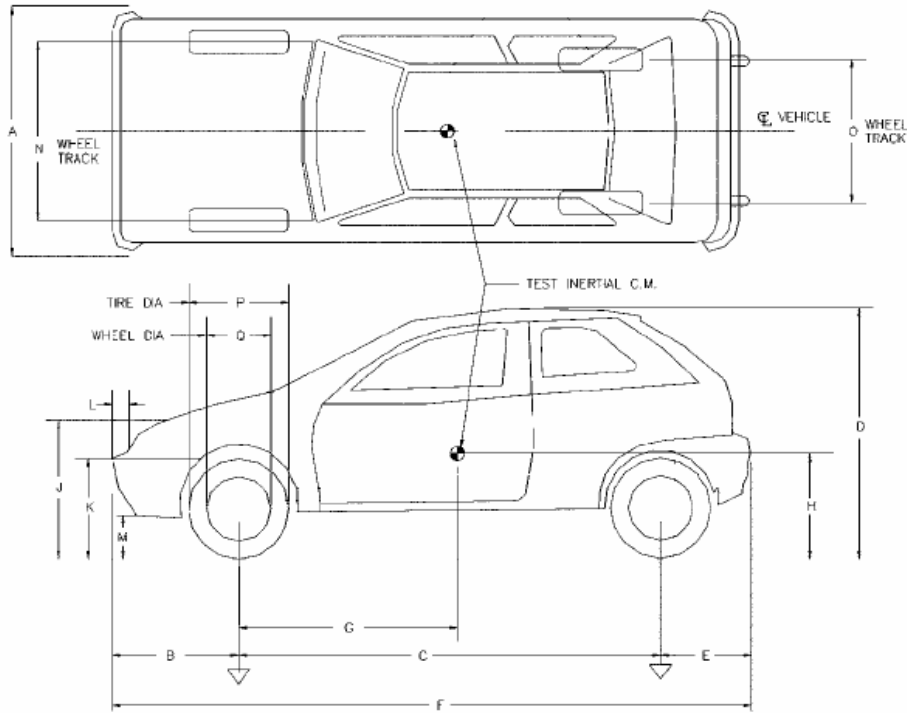

TEST VEHICLE GEOMETRY

	mm	in.		mm	in.		mm	in.		mm	in.
A	1592	62.7	E	590	23.2	J	545	21.5	N	1391	54.8
B	815	32.1	F	3765	148.2	K	540	21.3	O	1352	53.2
C	2360	92.9	G	800	31.5	L	108	4.3	P	555	21.9
D	1404	55.3	H	554	21.8	M	210	8.3	Q	365	14.4

DATA SHEET 3

OCCUPANT COMPARTMENT DEFORMATION INDEX

Test Article: ET-Plus 50' (15.24 m) System 4" Channel Project No. P35107-05

Test Program: 100 km/h 5° Guardrail Terminal Impact Test Test Date: 10/02/15

The seven subindices a, b, c, d, e, f and g indicate the percentage of reduction of seven interior dimensions shown on the following figure:

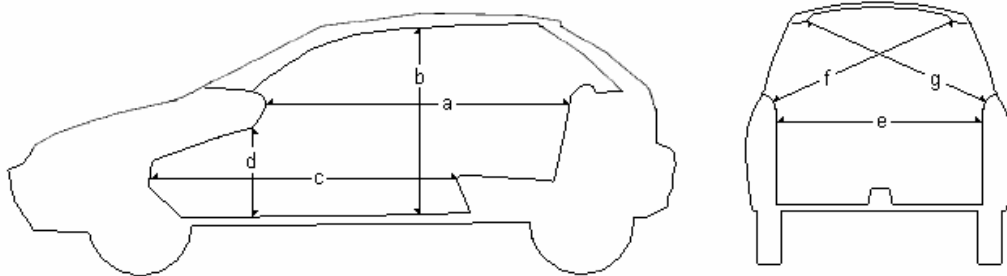

where,

- a = distance between the dashboard and a reference point at the rear of the occupant compartment, such as top of rear seat, or the rear part of the cab on a pickup;
- b = distance between the roof and the floor panel;
- c = distance between a reference point at the rear of the occupant compartment and the motor panel;
- d = distance between the lower dashboard and the floor panel;
- e = interior width;
- f = distance between the lower edge of right window and the upper edge of left window; and
- g = distance between the lower edge of left window and the upper edge of right window

Sub-Indices	Pre-Test		Post-Test		Percent Reduction
	mm	in.	mm	in.	
A	1573	61.9	1573	61.9	0.00%
B	1062	41.8	1064	41.9	-0.19%
C	1553	61.1	1553	61.1	0.00%
D	315	12.4	316	12.4	-0.32%
E	1260	49.6	1266	49.8	-0.48%
F	1183	46.6	1183	46.6	0.00%
G	1183	46.6	1183	46.6	0.00%
Max Deformation	N/A	N/A	N/A	N/A	N/A
OCDI	FS0000000				
Comments:	None				

DATA SHEET 4
SUMMARY OF RESULTS

Test Article: ET-Plus 50' (15.24 m) System 4" Channel
 Test Program: 100 km/h 5° Guardrail Terminal Impact Test

Project No.: P35107-05
 Test Date: 10/02/15

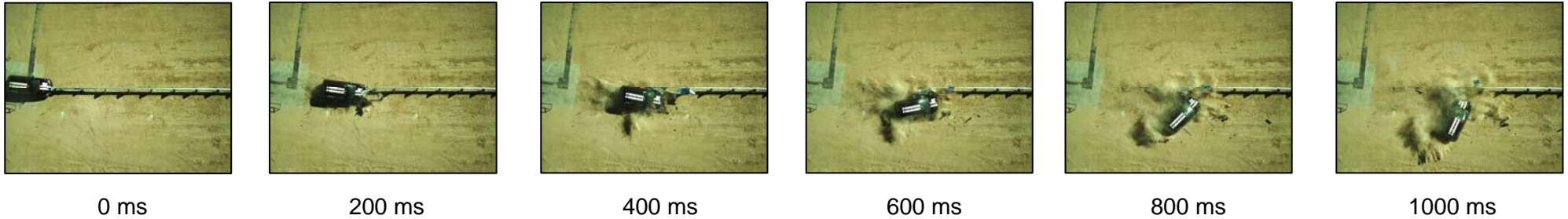

GENERAL INFORMATION		OCCUPANT RISK VALUES	
TEST AGENCY	KARCO Engineering, LLC.	FLAIL SPACE VELOCITY (m/s)	
TEST ARTICLE		X DIRECTION	7.9
TYPE	Terminal	Y DIRECTION	0.8
TERMINAL LENGTH ¹	15.2 m (49.9 ft.)	THIV (Optional) (m/s)	8.0
ADJOINING BARRIER LENGTH ²	34.3 m (112.4 ft.)	RIDEDOWN ACCELERATION (g)	
TEST VEHICLE		X DIRECTION	-14.1
TYPE	Production Model	Y DIRECTION	4.1
DESIGNATION	820C	PHD (Optional) (g)	14.5
MODEL	Chevrolet Metro	ASI (Optional)	0.8
MASS (CURB)	872.5 kg (1923.5 lbs)	VEHICLE DAMAGE	
MASS (TEST INERTIAL)	837.5 kg (1846.3 lbs)	INTERIOR	
DUMMY MASS	76.0 kg (167.5 lbs)	OCDI	FS0000000
MASS (GROSS STATIC)	913.0 kg (2012.9 lbs)	POST-IMPACT VEHICULAR BEHAVIOR	
IMPACT CONDITIONS		MAXIMUM ROLL ANGLE (°)	5.2 ³
VELOCITY (km/h)	99.22 km/h (61.65 mph)	MAXIMUM PITCH ANGLE (°)	-71.3 ³
ANGLE (°)	5.0	MAXIMUM YAW ANGLE (°)	-2.7 ³
IMPACT SEVERITY (kJ)	318.1		

¹ Terminal Length measured from Post 1 to Post 9
² Adjoining Barrier Length measured from Post 9 to Post 27
³ Maximum angles recorded during the first 1.0 s of the impact event

DATA SHEET 5
IMPACT CONDITIONS

Test Article: ET-Plus 50' (15.24 m) System 4" Channel Project No. P35107-05
Test Program: 100 km/h 5° Guardrail Terminal Impact Test Test Date: 10/02/15

Item	Value
Test Time	3:33 PM
Temperature (°C)	27.2 *
Wind Velocity (km/h)	14.5 *
Wind Direction	N *
Impact Speed (km/h)	99.22

*Information provided for reference only

DATA SHEET 6

TEST DATA SUMMARY

Test Article: ET-Plus 50' (15.24 m) System 4" Channel Project No. P35107-05
Test Program: 100 km/h 5° Guardrail Terminal Impact Test Test Date: 10/02/15

TEST VEHICLE DATA SUMMARY

Tested Parameter	Axis	Units	Max	Time (ms)	Min	Time (ms)
Vehicle Impact Velocity	X	m/s	27.6			
Flail Space Velocity	X	m/s	7.9	131.8		
Flail Space Velocity	Y	m/s	0.8	131.8		
Ridedown Acceleration	X	g	1.7	373.1	-14.1	188.8
Ridedown Acceleration	Y	g	4.1	380.2	-3.7	278.0

TEST VEHICLE ACCELEROMETER PEAK DATA

Location	Axis	Units	Max	Time (ms)	Min	Time (ms)
Vehicle CG	X	g	4.7	364.6	-22.5	28.5
Vehicle CG	Y	g	6.8	371.6	-6.1	46.7
Vehicle CG	Z	g	15.5	26.7	-13.6	37.5

**APPENDIX A
PHOTOGRAPHS**

LIST OF PHOTOGRAPHS

Figure		Page
1	Test Article, As-Received	A-1
2	Test Article, As-Received	A-1
3	Test Vehicle, As-Received	A-2
4	Test Vehicle, As-Received	A-2
5	Test Setup	A-3
6	Test Setup Close-Up	A-3
7	Test Setup	A-4
8	Test Setup Close-Up	A-4
9	Test Setup	A-5
10	Test Setup Close-Up	A-5
11	Test Setup	A-6
12	Test Setup Close-Up	A-6
13	Test Setup	A-7
14	Test Setup Close-Up	A-7
15	Pre-Test	A-8
16	Post-Test	A-8
17	Post-Test	A-9
18	Post-Test	A-9
19	Pre-Test Front View of Test Article	A-10
20	Post-Test Front View of Test Article	A-10
21	Pre-Test Right Front $\frac{3}{4}$ View of Test Article	A-11
22	Post-Test Right Front $\frac{3}{4}$ View of Test Article	A-11
23	Pre-Test Right View of Test Article	A-12
24	Post-Test Right View of Test Article	A-12
25	Pre-Test Right Rear $\frac{3}{4}$ View of Test Article	A-13
26	Post-Test Right Rear $\frac{3}{4}$ View of Test Article	A-13
27	Pre-Test Rear View of Test Article	A-14
28	Post-Test Rear View of Test Article	A-14
29	Pre-Test Left Rear $\frac{3}{4}$ View of Test Article	A-15
30	Post-Test Left Rear $\frac{3}{4}$ View of Test Article	A-15
31	Pre-Test Left View of Test Article	A-16
32	Post-Test Left View of Test Article	A-16
33	Pre-Test Left Front $\frac{3}{4}$ View of Test Article	A-17
34	Post-Test Left Front $\frac{3}{4}$ View of Test Article	A-17

LIST OF PHOTOGRAPHS ... (CONTINUED)

Figure		Page
35	Test Article Damage	A-18
36	Test Article Damage	A-18
37	Test Article Damage	A-19
38	Test Article Damage	A-19
39	Test Article Damage	A-20
40	Pre-Test Left View of Test Vehicle	A-20
41	Post-Test Left View of Test Vehicle	A-21
42	Pre-Test Left Front $\frac{3}{4}$ View of Test Vehicle	A-21
43	Post-Test Left Front $\frac{3}{4}$ View of Test Vehicle	A-22
44	Pre-Test Front View of Test Vehicle	A-22
45	Post-Test Front View of Test Vehicle	A-23
46	Pre-Test Right Front $\frac{3}{4}$ View of Test Vehicle	A-23
47	Post-Test Right Front $\frac{3}{4}$ View of Test Vehicle	A-24
48	Pre-Test Right View of Test Vehicle	A-24
49	Post-Test Right View of Test Vehicle	A-25
50	Pre-Test View of Windshield	A-25
51	Post-Test View of Windshield	A-26
52	Pre-Test View of Driver's Side Occupant Compartment	A-26
53	Post-Test View of Driver's Side Occupant Compartment	A-27
54	Pre-Test View of Driver's Side Floorpan	A-27
55	Post-Test View of Driver's Side Floorpan	A-28
56	Pre-Test View of Passenger's Side Occupant Compartment	A-28
57	Post-Test View of Passenger's Side Occupant Compartment	A-29
58	Pre-Test View of Passenger's Floorpan	A-29
59	Post-Test View of Passenger's Floorpan	A-30
60	Test Vehicle Manufacturer's Label	A-30



FIGURE 1. Test Article, As Received



FIGURE 2. Test Article, As Received



FIGURE 3. Test Vehicle, As Received



FIGURE 4. Test Vehicle, As Received



FIGURE 5. Test Setup



FIGURE 6. Test Setup Close-Up



FIGURE 7. Test Setup



FIGURE 8. Test Setup Close-Up



FIGURE 9. Test Setup

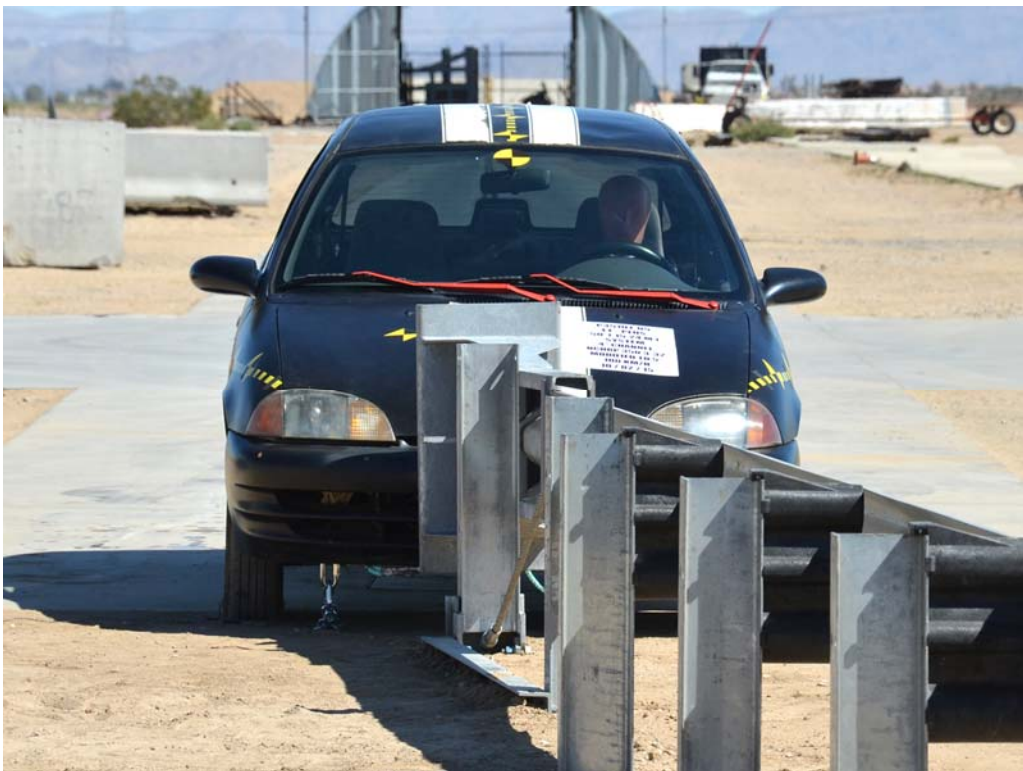

FIGURE 10. Test Setup Close-Up



FIGURE 11. Test Setup



FIGURE 12. Test Setup Close-Up



FIGURE 13. Test Setup



FIGURE 14. Test Setup Close-Up



FIGURE 15. Pre-Test



FIGURE 16. Post-Test



FIGURE 17. Post-Test



FIGURE 18. Post-Test



FIGURE 19. Pre-Test Front View of Test Article



FIGURE 20. Post-Test Front View of Test Article



FIGURE 21. Pre-Test Right Front $\frac{3}{4}$ View of Test Article



FIGURE 22. Post-Test Right Front $\frac{3}{4}$ View of Test Article



FIGURE 23. Pre-Test Right View of Test Article



FIGURE 24. Post-Test Right View of Test Article



FIGURE 25. Pre-Test Right Rear $\frac{3}{4}$ View of Test Article



FIGURE 26. Post-Test Right Rear $\frac{3}{4}$ View of Test Article



FIGURE 27. Pre-Test Rear View of Test Article



FIGURE 28. Post-Test Rear View of Test Article



FIGURE 29. Pre-Test Left Rear $\frac{3}{4}$ View of Test Article



FIGURE 30. Post-Test Left Rear $\frac{3}{4}$ View of Test Article



FIGURE 31. Pre-Test Left View of Test Article



FIGURE 32. Post-Test Left View of Test Article



FIGURE 33. Pre-Test Left Front $\frac{3}{4}$ View of Test Article



FIGURE 34. Post-Test Left Front $\frac{3}{4}$ View of Test Article



FIGURE 35. Test Article Damage



FIGURE 36. Test Article Damage



FIGURE 37. Test Article Damage



FIGURE 38. Test Article Damage



FIGURE 39. Test Article Damage



FIGURE 40. Pre-Test Left View of Test Vehicle



FIGURE 41. Post-Test Left View of Test Vehicle



FIGURE 42. Pre-Test Left Front ¼ View of Test Vehicle



FIGURE 43. Post-Test Left Front 3/4 View of Test Vehicle



FIGURE 44. Pre-Test Front View of Test Vehicle



FIGURE 45. Post-Test Front View of Test Vehicle



FIGURE 46. Pre-Test Right Front $\frac{3}{4}$ View of Test Vehicle



FIGURE 47. Post-Test Right Front 3/4 View of Test Vehicle



FIGURE 48. Pre-Test Right View of Test Vehicle



FIGURE 49. Post-Test Right View of Test Vehicle



FIGURE 50. Pre-Test View of Windshield



FIGURE 51. Post-Test View of Windshield



FIGURE 52. Pre-Test View of Driver's Side Occupant Compartment



FIGURE 53. Post-Test View of Driver's Side Occupant Compartment



FIGURE 54. Pre-Test View of Driver's Side Floorpan



FIGURE 55. Post-Test View of Driver's Side Floorpan



FIGURE 56. Pre-Test View of Passenger's Side Occupant Compartment



FIGURE 57. Post-Test View of Passenger's Side Occupant Compartment



FIGURE 58. Pre-Test View of Passenger's Floorpan



FIGURE 59. Post-Test View of Passenger's Floorpan



FIGURE 60. Test Vehicle Manufacturer's Label

**APPENDIX B
DATA PLOTS**

LIST OF DATA PLOTS

<u>Plot</u>		<u>Page</u>
1	Test Vehicle CG X	B-1
2	Test Vehicle CG X Moving Average	B-1
3	Test Vehicle CG X Velocity	B-1
4	Test Vehicle CG X Displacement	B-1
5	Test Vehicle CG Y	B-2
6	Test Vehicle CG Y Moving Average	B-2
7	Test Vehicle CG Y Velocity	B-2
8	Test Vehicle CG Y Displacement	B-2
9	Test Vehicle CG Z	B-3
10	Test Vehicle Accident Severity Index	B-3
11	Test Vehicle Roll Angle	B-4
12	Test Vehicle Yaw Angle	B-4
13	Test Vehicle Pitch Angle	B-4

Test Article: ET-Plus 50' (15.24 m) System 4" Channel
 Test Program: 100 km/h 5" Guardrail Terminal Impact Test

Project No: P35107-05
 Test Date.: 10/1/15

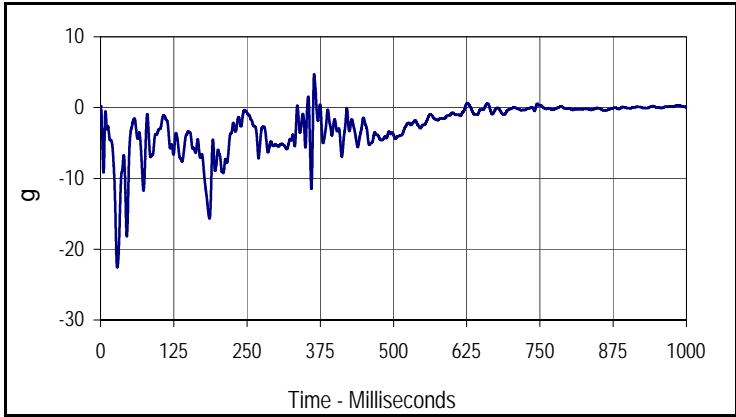

Curve Description			
Test Vehicle CG X			
Plot No.	Type	SAE Class	Units
001	FIL	60	g
Max	Time	Min	Time
4.7	364.6	-22.5	28.5

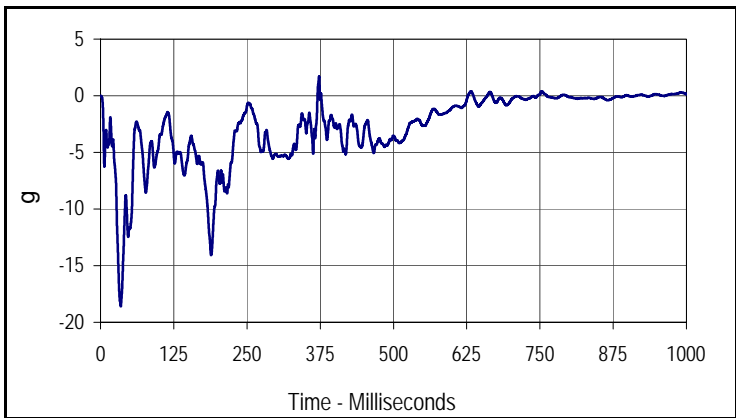

Curve Description			
Test Vehicle CG X Moving Average			
Plot No.	Type	SAE Class	Units
002	AVG	180	g
Max	Time	Min	Time
1.7	373.1	-18.6	34.7

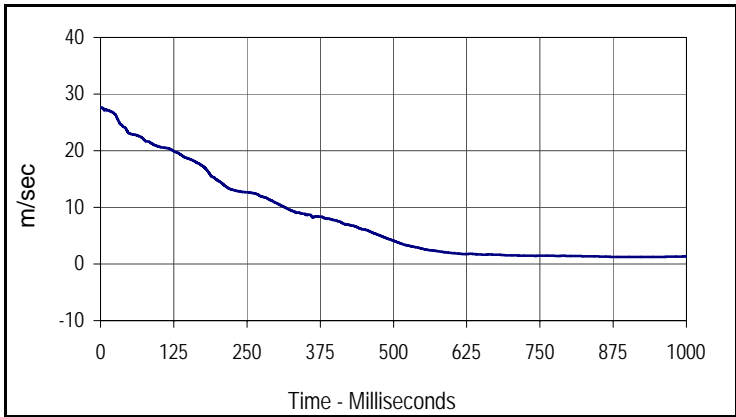

Curve Description			
Test Vehicle CG X Velocity			
Plot No.	Type	SAE Class	Units
003	IN1	180	m/sec
Max	Time	Min	Time
27.6	0.0	1.2	906.7

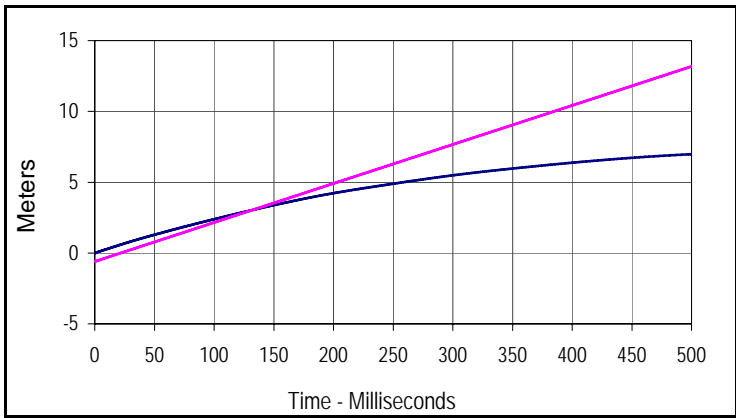

Curve Description			
Test Vehicle CG X Displacement			
Plot No.	Type	SAE Class	Units
004	IN2	180	Meters
Max	Time	Min	Time
7.8	999.9	0.0	0.0

— Vehicle CG X Displacement
 — Occupant X Displacement

Test Article: ET-Plus 50' (15.24 m) System 4" Channel
 Test Program: 100 km/h 5" Guardrail Terminal Impact Test

Project No: P35107-05
 Test Date.: 10/1/15

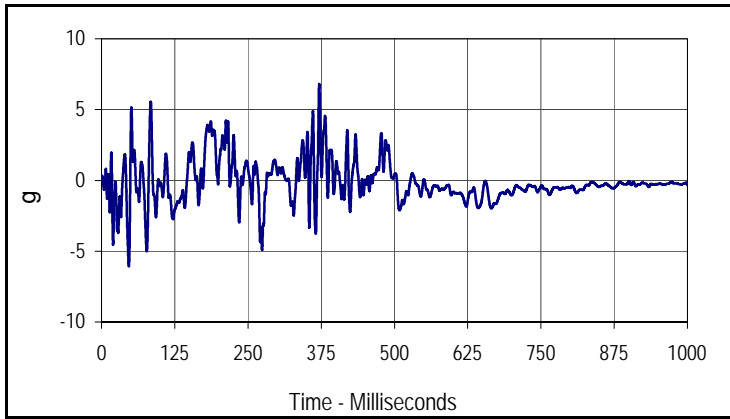

Curve Description			
Test Vehicle CG Y			
Plot No.	Type	SAE Class	Units
005	FIL	60	g
Max	Time	Min	Time
6.8	371.6	-6.1	46.7

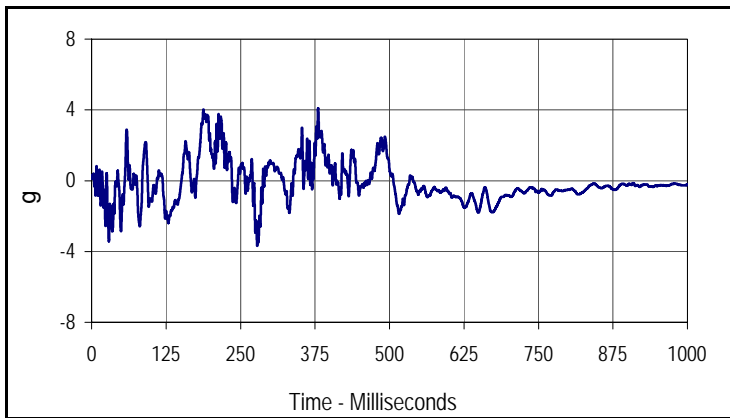

Curve Description			
Test Vehicle CG Y Moving Average			
Plot No.	Type	SAE Class	Units
006	AVG	180	g
Max	Time	Min	Time
4.1	380.2	-3.7	278.0

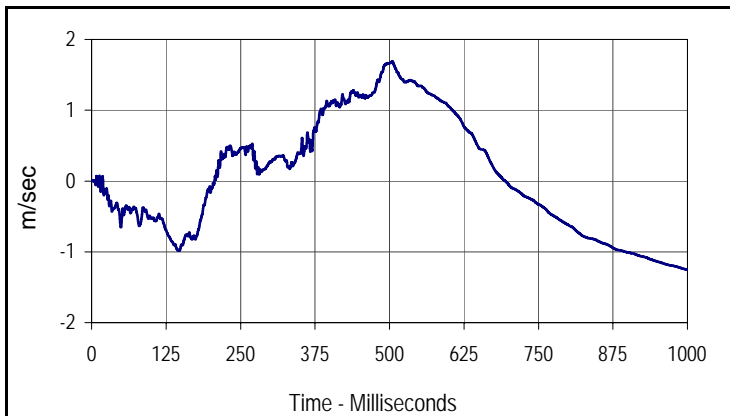

Curve Description			
Test Vehicle CG Y Velocity			
Plot No.	Type	SAE Class	Units
007	IN1	180	m/sec
Max	Time	Min	Time
1.7	504.7	-1.3	999.9

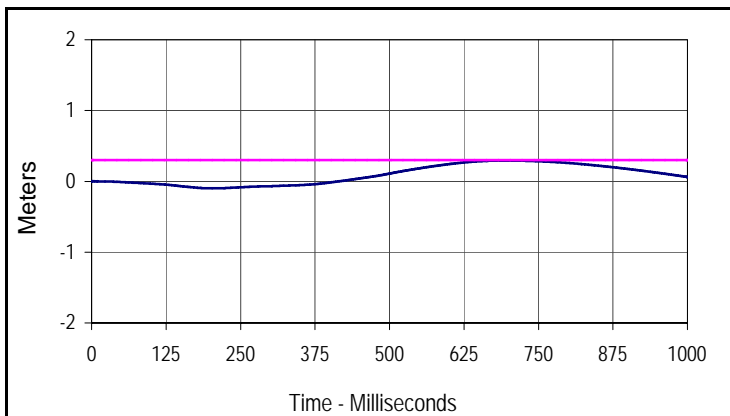

Curve Description			
Test Vehicle CG Y Displacement			
Plot No.	Type	SAE Class	Units
008	IN2	180	Meters
Max	Time	Min	Time
0.3	693.9	-0.1	206.2

— Vehicle CG Y Displacement
 — Occupant Y Displacement

Test Article: ET-Plus 50' (15.24 m) System 4" Channel
 Test Program: 100 km/h 5" Guardrail Terminal Impact Test

Project No: P35107-05
 Test Date.: 10/1/15

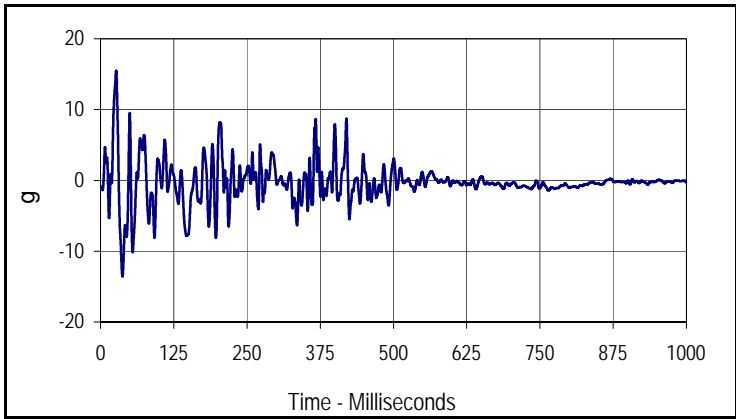

Curve Description			
Test Vehicle CG Z			
Plot No.	Type	SAE Class	Units
009	FIL	60	g
Max	Time	Min	Time
15.5	26.7	-13.6	37.5

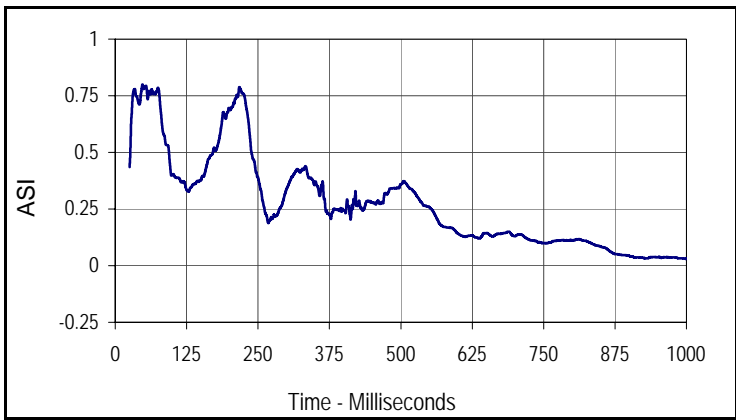

Curve Description			
Test Vehicle Accident Severity Index			
Plot No.	Type	SAE Class	Units
010	ASI	180	ASI
Max	Time	Min	Time
0.8	47.8	0.0	999.2

Test Article: ET-Plus 50' (15.24 m) System 4" Channel
 Test Program: 100 km/h 5" Guardrail Terminal Impact Test

Project No: P35107-05
 Test Date.: 10/1/15

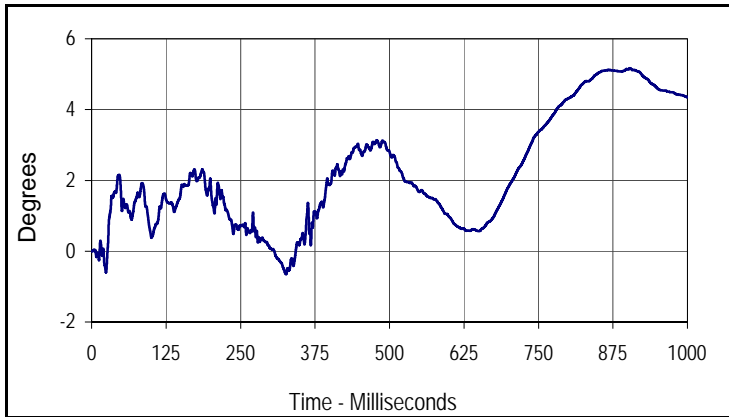

Curve Description			
Test Vehicle Roll Angle			
Plot No.	Type	SAE Class	Units
011	IN1	180	Degrees
Max	Time	Min	Time
5.2	903.3	-0.7	326.5

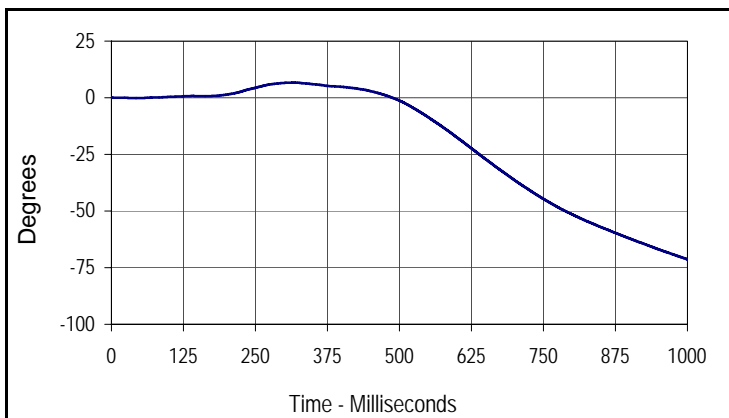

Curve Description			
Test Vehicle Yaw Angle			
Plot No.	Type	SAE Class	Units
012	IN1	180	Degrees
Max	Time	Min	Time
6.7	314.9	-71.3	999.9

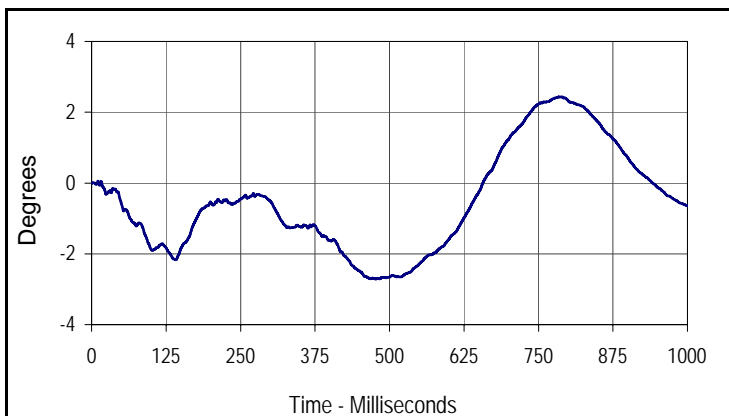

Curve Description			
Test Vehicle Pitch Angle			
Plot No.	Type	SAE Class	Units
013	IN1	180	Degrees
Max	Time	Min	Time
2.4	789.5	-2.7	476.9

**APPENDIX C
INSTRUMENTATION**

DATA ACQUISITION INFORMATION

Test Article: ET-Plus 50' (15.24 m) System 4" Channel Project No. P35107-05
Test Program: 100 km/h 5° Guardrail Terminal Impact Test Test Date: 10/02/15

VEHICLE INSTRUMENTATION

CH	Location	Axis	Ident. No.	Description	MFR	Model	Units
1	Vehicle CG	X	J48139	Accel, Half Bridge	Endevco	2000G	g
2	Vehicle CG	Y	J48135	Accel, Half Bridge	Endevco	2000G	g
3	Vehicle CG	Z	J48123	Accel, Half Bridge	Endevco	2000G	g
4	Vehicle CG	Yaw	ARS8486	Rate Gyro	DTS	ARS-18K	Deg/s
5	Vehicle CG	Pitch	ARS8532	Rate Gyro	DTS	ARS-18K	Deg/s
6	Vehicle CG	Roll	ARS8537	Rate Gyro	DTS	ARS-18K	Deg/s

APPENDIX D
MANUFACTURER DOCUMENTS

LIST OF FIGURES

<u>Figure</u>		<u>Page</u>
61	Manufacturer's Drawing	D-1
62	Overhead Illustration	D-2

ET- PLUS™
50' (15.24 m) System
 FOR SPECIFIC DETAILS, REFER TO THE TRINITY ET
 DRAWING(S)
 AND THE STATE STANDARD DRAWING(S)

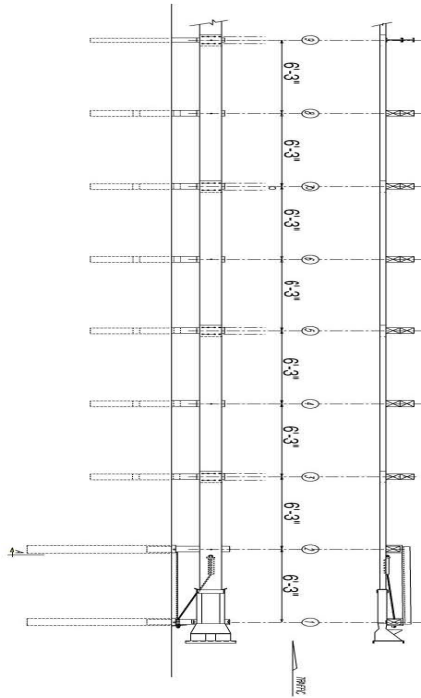

(This represents 1 version of the 50' (15.24 m) system)

NOTES:

1. Alternate to long foundation tube without soil plate is short tube with soil plate at locations 1 and 2, Hinged Breakaway (HBA) Post™ at locations 1 and 2, or Hinged Breakaway (HBA) Post™ at location 1 and Steel Yielding Terminal Post™ (SYTP) at location 2; long foundation tube or short tube with soil plate at location 1 and SYTP at location 2.
2. Alternate to two 12'6" (3.81 m) long rail elements is one 25'0" (7.62 m) long rail element.
3. Short steel foundation tubes without soil plates and breakaway wood posts, or Hinged Breakaway (HBA) Post™ may be specified for locations 3 and 4. Controlled Release Terminal (CRT) posts can be used for post locations 5 through 8.
4. Alternates to Note 3 combinations for locations 3 through 8 are: 1) All short tubes without soil plates and breakaway wood posts; 2) All HBA posts; 3) All CRT posts; 4) All SYTP.

FIGURE 61. Manufacturer's Drawing

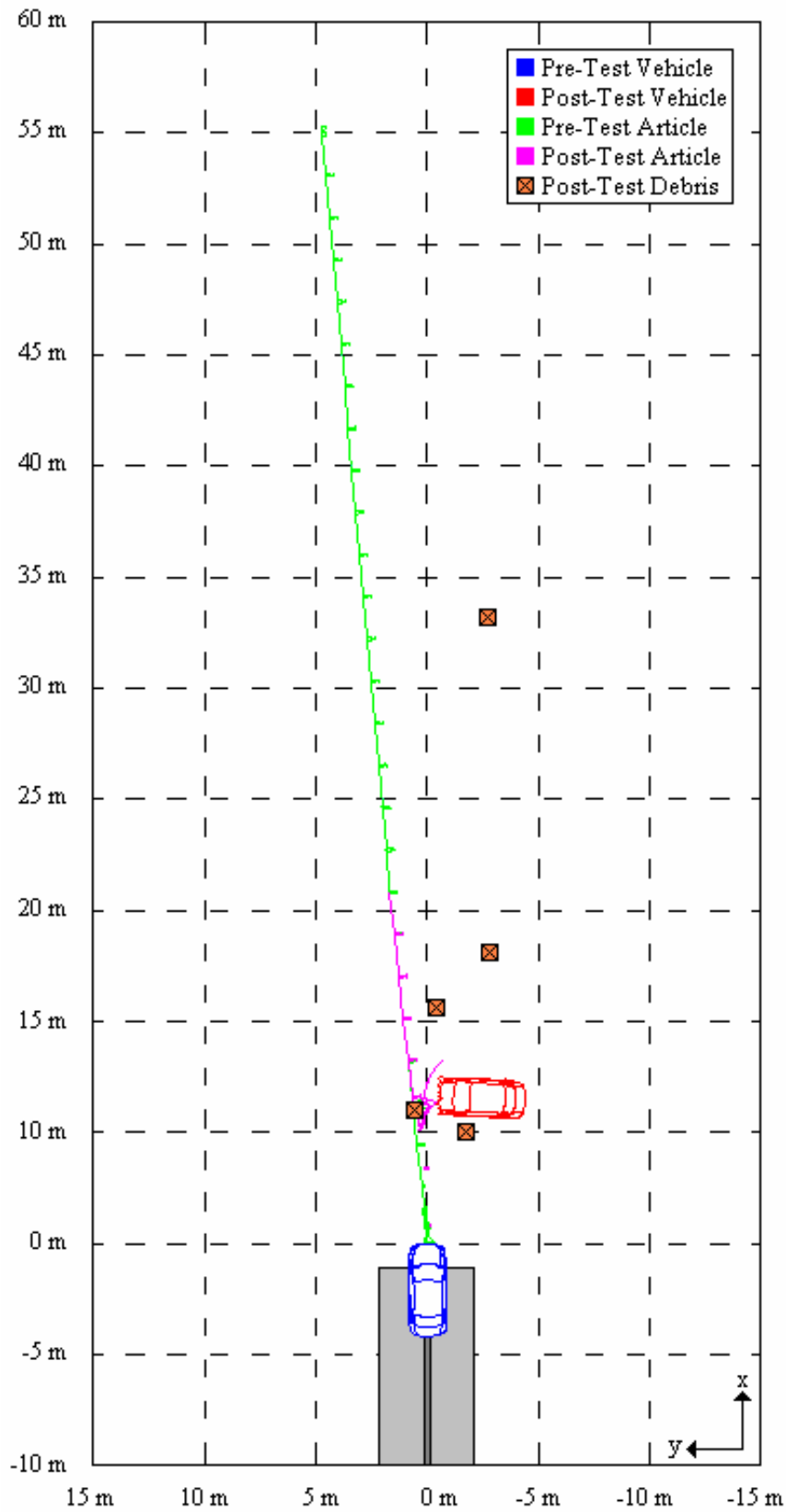

FIGURE 62. Overhead Illustration

FINAL PAGE OF REPORT